

Single-Phase Power Controllers

SPC Series

INSTRUCTION MANUAL

TCD210145AB

Autonics

Thank you for choosing our Autonics product.

Read and understand the instruction manual and manual thoroughly before using the product.

For your safety, read and follow the below safety considerations before using.

For your safety, read and follow the considerations written in the instruction manual, other manuals and Autonics website.

Keep this instruction manual in a place where you can find easily.

The specifications, dimensions, etc. are subject to change without notice for product improvement. Some models may be discontinued without notice.

Follow Autonics website for the latest information.

Safety Considerations

- Observe all 'Safety Considerations' for safe and proper operation to avoid hazards.
- ⚠ symbol indicates caution due to special circumstances in which hazards may occur.

⚠ Warning Failure to follow instructions may result in serious injury or death.

- Fail-safe device must be installed when using the unit with machinery that may cause serious injury or substantial economic loss. (e.g. nuclear power control, medical equipment, ships, vehicles, railways, aircraft, combustion apparatus, safety equipment, crime / disaster prevention devices, etc.)**
Failure to follow this instruction may result in personal injury, economic loss or fire.
- Do not use the unit in the place where flammable / explosive / corrosive gas, high humidity, direct sunlight, radiant heat, vibration, impact, or salinity may be present.**
Failure to follow this instruction may result in explosion or fire.
- Install on the device panel, and ground to the F.G. terminal separately.**
Failure to follow this instruction may result in fire or electric shock.
- Do not connect, repair, or inspect the unit while connected to a power source.**
Failure to follow this instruction may result in fire or electric shock.
- Check 'Connections' before wiring.**
Failure to follow this instruction may result in fire.
- Do not disassemble or modify the unit.**
Failure to follow this instruction may result in fire or electric shock.

⚠ Caution Failure to follow instructions may result in injury or product damage.

- Use the unit within the rated specifications.**
Failure to follow this instruction may result in fire or product damage.
- Use a dry cloth to clean the unit, and do not use water or organic solvent.**
Failure to follow this instruction may result in fire.
- Keep the product away from metal chip, dust, and wire residue which flow into the unit.**
Failure to follow this instruction may result in fire or product damage.

Cautions during Use

- Follow instructions in 'Cautions during Use'. Otherwise, it may cause unexpected accidents.
- Use the product, after 3 sec of supplying power.
- Before use, set the mode and function according to the specification. Especially, be cautious that the product does not operate when OUT ADJ. is set to 0%. Since mode/parameter can not be changed during operation, set the mode and function after turning off the power.
- To ensure the reliability of the product, install the product on the panel or metal surface vertically to the ground.
- Install the unit in the well ventilated place.
- While supplying power to the load or right after turning off the power of the load, do not touch the body and heat sink. Failure to follow this instruction may result in a burn due to the high temperature.
- Install a power switch or circuit breaker in the easily accessible place for supplying or disconnecting the power.
- Do not wire to terminals which are not used.
- The rapid fuse must be connected between R terminal and the power source.
- Do not use near the equipment which generates strong magnetic force or high frequency noise.
- This unit may be used in the following environments.
 - Indoors (in the environment condition rated in 'Specifications')
 - Altitude max. 2,000 m
 - Pollution degree 2
 - Installation category III

Ordering Information

This is only for reference, the actual product does not support all combinations. For selecting the specified model, follow the Autonics website.

SPC	1	-	2
1 Control phases			2 Rated load current
1: Single-phase			Number: Rated load current (unit: A)

Product Components

- Product
- Instruction manual
- Bolt × 2

Specifications

Model	SPC1-35	SPC1-50
Control phase	Single-phase	
Rated load current	35 A	50 A
Indicator	Output indicator (red)	
Control input	1 - 5 VDC \equiv , DC 4 - 20 mA (250 Ω), ON / OFF (external contact or 24 VDC \equiv), external adjuster (1 k Ω), output limit input (front output limit adjuster)	
Cooling method	Natural air cooling	
Control circuit	MICOM control method	
Unit weight	\approx 1 kg	
Certification	EAC	

Control method	Phase control	Cycle control	ON/OFF control
Control mode	Normal	Fixed cycle	-
Applied load	Resistance load		
Output range	0 to 98 %	0 to 100 %	0 / 100 %

Power supply	220 VAC \sim 50 / 60Hz
Permissible voltage range	90 to 110 % of rated voltage
Operating freq. fluctuation	\pm 1 Hz
Min. load current	5 % of rated load current
Insulation resistance	100 M Ω (500 VDC \equiv megger)
Dielectric strength	Between the charging part and the case: 3,000 VAC \sim 50 / 60 Hz for 1 min
Noise immunity	\pm 2 kV square wave noise (pulse width: 1 μ s) by the noise simulator
Vibration	0.75 mm double amplitude at frequency of 10 to 55 Hz in each X, Y, Z direction for 1 hour
Vibration (malfunction)	0.5 mm double amplitude at frequency of 10 to 55 Hz in each X, Y, Z direction for 10 min
Shock	300 m/s 2 (\approx 30 G) in each X, Y, Z direction for 3 times
Shock (malfunction)	100 m/s 2 (\approx 10 G) in each X, Y, Z direction for 3 times
Ambient temperature	0 to 50 $^{\circ}$ C, storage: -25 to 65 $^{\circ}$ C (no freezing or condensation)
Ambient humidity	35 to 85 %RH, storage: 35 to 85 %RH (no freezing or condensation)
Wiring specification	Rated load current 35 A: AWG 16 to 8 Rated load current 50 A: AWG 8 to 6

Dimensions

- Unit: mm, For the detailed drawings, follow the Autonics website.

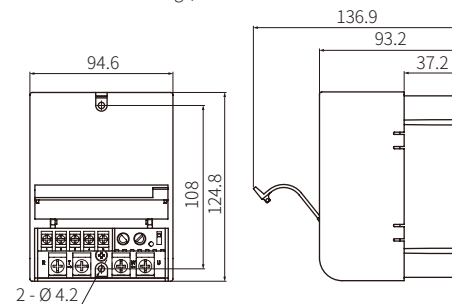

Unit Descriptions

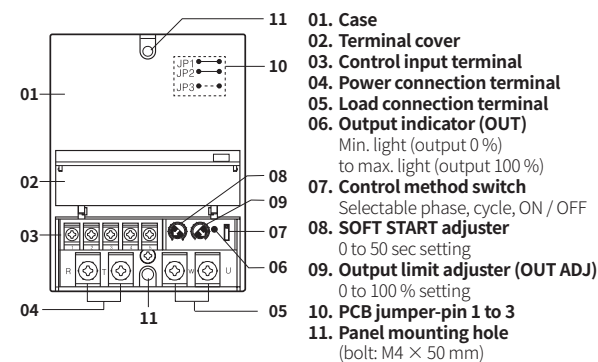

Cautions during Installation

⚠ High Temperature Caution

While supplying power to the load or right after turning off the power of the load, do not touch the body and heatsink. Failure to follow this instruction may result in a burn due to the high temperature.

■ Mount space

- Unit: mm
- When installing multiple power controllers, keep space between power controllers for heat radiation. Horizontal: \geq 30 mm, vertical: \geq 100 mm

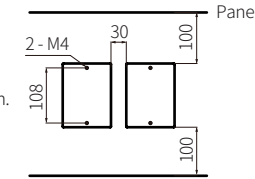

Cautions during Wiring

■ Crimp Terminal Specifications

- Unit: mm, Use crimp terminals of size specified below.

	Control input	Output and power
a	\geq 3.5 mm	\geq 5 mm
b	\leq 7.0 mm	\leq 12 mm

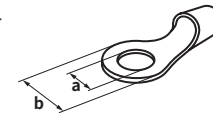

■ Terminal Screw Specifications

	Control input	Output and power
Screw	M3.5	M5
Tightening torque	0.6 to 1.2 N m	1.5 to 2.2 N m

Connections

■ DC 4 - 20 mA

- It controls 0 to 100 % when you supply DC 4 to 20 mA on 4, 5 terminals when power is supplied.
- Output control is available via OUT ADJ. If not using this, set as 100 %.
- Supported control method : Phase / cycle control

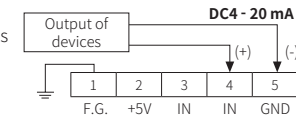

■ 1 - 5 VDC \equiv

- It controls 0 to 100 % when you 1 to 5 VDC \equiv on 3, 5 terminals when power is supplied.
- Output control is available via OUT ADJ. If not using this, set as 100 %.
- Supported control method : Phase / cycle control

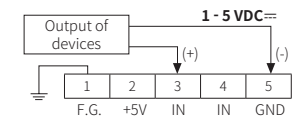

■ External contact

- It controls 100 % if you connect external contact or switch to 2, 3 terminal when it is ON, it controls 0 % when it is OFF.
- Output control is available via OUT ADJ. If not using this, set as 100 %.
- Supported control method : Phase / cycle / ON/OFF control

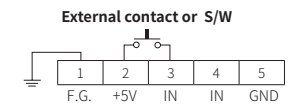

■ External adjuster

- After power is applied, connecting the external adjuster 1 k Ω to 2, 3 and 4 terminals and turning adjuster control from 0 to 100 %.
- In another way, connecting to the 2 and 3 terminals and turning OUT ADJ control from 0 to 100 %.
- Supported control method : Phase / cycle control

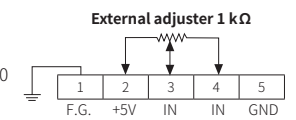

■ External 24 VDC \equiv

- It can be used with external 24 VDC \equiv voltage input at ON/OFF control method.
- It is available to control of ON/OFF, outputs 100 % for applying 24 VDC \equiv and 0 % for applying 0 VDC \equiv .
- Supported control method : Phase / cycle / ON/OFF control

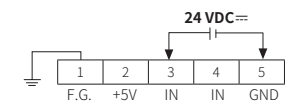

■ Example connection of not using external adjuster

- It is possible to control 0 to 100 % with turning OUT ADJ. in state of connecting terminal 2 and terminal 3.

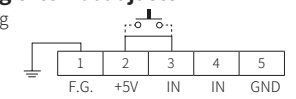

External Connections

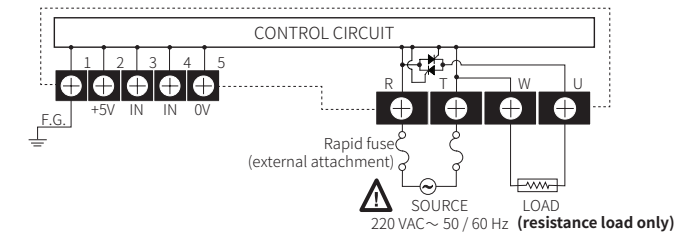

Case Removal Method

After disconnecting all power sources supplied to the product, remove the case, Push the Joint part (4 points) on the right and left side of the case with the flat head screwdriver, and disassemble the case.

⚠ Caution: When using the tools, be careful not to be wounded.

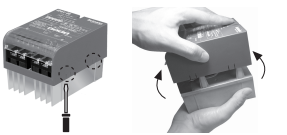

Derating Curve

— Vertical mount - - - Horizontal mount ⁽¹⁾

01) Two mounting holes and terminal blocks are the same height

■ SPC1-35

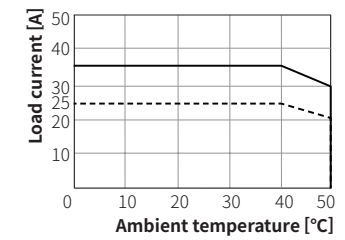

■ SPC1-50

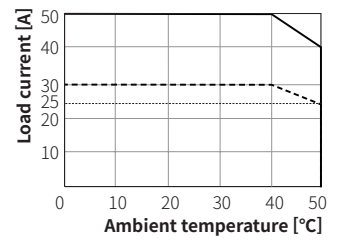

Control Method Setting

- The control method setting cannot be changed while it is operating. Turn OFF the power at first then change the setting and supply the power again.
- Factory default: Phase control / JP1 to 3: SHORT (phase equal division / cycle 0.5 sec)

Control method	Phase control	Cycle control (zero cross turn-on)	ON/OFF control (zero cross turn-on)
Control method switch	PHASE CYCLE ON/OFF	PHASE CYCLE ON/OFF	PHASE CYCLE ON/OFF
PCB JP setting	Division method (JP3)	Cycle (JP1 / 2)	-

■ PCB JP setting

	Phase control : Division method		Cycle control (zero cross turn-on) : Cycle			
	Phase equal division	Power equal division	None	0.5 sec	2.0 sec	10 sec
JP1	-	-	OPEN	SHORT	SHORT	OPEN
JP2	-	-	OPEN	SHORT	OPEN	SHORT
JP3	SHORT	OPEN	-	-	-	-

